



# IT100

IntelliTone™ Pro Toner and Probe

## Users Manual

March 2006

© 2006 Fluke Corporation. All rights reserved.

All product names are trademarks of their respective companies.

## **LIMITED WARRANTY AND LIMITATION OF LIABILITY**

Each Fluke Networks product is warranted to be free from defects in material and workmanship under normal use and service. The warranty period for the mainframe is one year and begins on the date of purchase. Parts, accessories, product repairs and services are warranted for 90 days, unless otherwise stated. Ni-Cad, Ni-MH and Li-Ion batteries, cables or other peripherals are all considered parts or accessories. The warranty extends only to the original buyer or end user customer of a Fluke Networks authorized reseller, and does not apply to any product which, in Fluke Networks' opinion, has been misused, abused, altered, neglected, contaminated, or damaged by accident or abnormal conditions of operation or handling. Fluke Networks warrants that software will operate substantially in accordance with its functional specifications for 90 days and that it has been properly recorded on non-defective media. Fluke Networks does not warrant that software will be error free or operate without interruption.

Fluke Networks authorized resellers shall extend this warranty on new and unused products to end-user customers only but have no authority to extend a greater or different warranty on behalf of Fluke Networks. Warranty support is available only if product is purchased through a Fluke Networks authorized sales outlet or Buyer has paid the applicable international price. Fluke Networks reserves the right to invoice Buyer for importation costs of repair/replacement parts when product purchased in one country is submitted for repair in another country.

Fluke Networks warranty obligation is limited, at Fluke Networks option, to refund of the purchase price, free of charge repair, or replacement of a defective product which is returned to a Fluke Networks authorized service center within the warranty period.

To obtain warranty service, contact your nearest Fluke Networks authorized service center to obtain return authorization information, then send the product to that service center, with a description of the difficulty, postage and insurance prepaid (FOB destination). Fluke Networks assumes no risk for damage in transit. Following warranty repair, the product will be returned to Buyer, transportation prepaid (FOB destination). If Fluke Networks determines that failure was caused by neglect, misuse, contamination, alteration, accident or abnormal condition of operation or handling, or normal wear and tear of mechanical components, Fluke Networks will provide an estimate of repair costs and obtain authorization before commencing the work. Following repair, the product will be returned to the Buyer transportation prepaid and the Buyer will be billed for the repair and return transportation charges (FOB Shipping point).

**THIS WARRANTY IS BUYER'S SOLE AND EXCLUSIVE REMEDY AND IS IN LIEU OF ALL OTHER WARRANTIES, EXPRESS OR IMPLIED, INCLUDING BUT NOT LIMITED TO ANY IMPLIED WARRANTY OR MERCHANTABILITY OR FITNESS FOR A PARTICULAR PURPOSE. FLUKE NETWORKS SHALL NOT BE LIABLE FOR ANY SPECIAL, INDIRECT, INCIDENTAL OR CONSEQUENTIAL DAMAGES OR LOSSES, INCLUDING LOSS OF DATA, ARISING FROM ANY CAUSE OR THEORY.**

Since some countries or states do not allow limitation of the term of an implied warranty, or exclusion or limitation of incidental or consequential damages, the limitations and exclusions of this warranty may not apply to every buyer. If any provision of this Warranty is held invalid or unenforceable by a court or other decision-maker of competent jurisdiction, such holding will not affect the validity or enforceability of any other provision.

# Table of Contents

Title	Page
Overview of Features.....	1
Registration.....	2
Contacting Fluke Networks.....	2
Unpacking.....	3
ITK100 IntelliTone Pro Kit.....	3
IT100 IntelliTone Pro Toner.....	3
IT100 IntelliTone Pro Probe.....	3
Safety Information.....	4
Battery Status.....	5
Auto Power Down.....	5
Locating and Isolating Terminated UTP/STP Cables with the IntelliTone.....	5
Isolating Individual Wire Pairs with the SmartTone Analog Function.....	8
SmartTone Positive Identification.....	8
Validating Telephone Service and Polarity.....	9
Testing for Continuity.....	10
Validating Cable Maps with an IT200 Probe.....	10
Maintenance.....	11

Battery Life and Replacement.....	11
Accessories .....	12
Specifications .....	13
Environmental and Regulatory Specifications .....	14
IT100 Toner Electrical and Functional Specifications.....	15
IT100 Probe Electrical and Functional Specifications.....	15
Feature Compatibility.....	16
Certifications and Compliance .....	16
Dimensions.....	16
Weight (with battery).....	16

# ***IT100 IntelliTone™ Pro Toner*** ***IT100 IntelliTone™ Pro Probe***

## ***Overview of Features***

The IT100 IntelliTone™ Pro toner and probe let you locate and isolate twisted pair (UTP, Cat 5e, Cat 6), coax cables (RG6, RG59, and others for CATV/CCTV), bare wire (such as speaker wire and security network wire), and Cat 3 telephone cabling. The toner also lets you validate voice service.

The toner and probe feature both digital and analog toning and detection. The digital IntelliTone tone is primarily used on data cables, and on active networks. In these environments, the digital signal eliminates cable misidentification due to signal bleed and radiated or ambient noise.

The analog tone is primarily used on voice cables, and on bare wire. The SmartTone™ analog technology will

change cadence when a pair is shorted at the far end. This makes exact pair identification easy and precise.

The IT100 toner and probe also provide standard functions such as visual and audible signal strength indication, digital toning/detection, SmartTone analog toning/detection, and continuity testing.

## Registration

Registering your product with Fluke Networks gives you access to valuable information on product updates, troubleshooting tips, and other support services. To register, fill out the online registration form on the Fluke Networks website at [www.flukenetworks.com/registration](http://www.flukenetworks.com/registration). If you do not have Internet access, print the registration form from the CD included with the product. Fill out the form, then mail or fax it to the appropriate address for your country.

## Contacting Fluke Networks

For technical support, please contact us via [support@flukenetworks.com](mailto:support@flukenetworks.com).



[www.flukenetworks.com](http://www.flukenetworks.com)



[support@flukenetworks.com](mailto:support@flukenetworks.com)



+1-425-446-4519

- Australia: 61 (2) 8850-3333 or 61 (3) 9329-0244
- Beijing: 86 (10) 6512-3435
- Brazil: 11 3044 1277
- Canada: 1-800-363-5853
- Europe: +44-(0)1923-281-300
- Hong Kong: 852 2721-3228
- Japan: 03-3434-0510
- Korea: 82 2 539-6311
- Singapore: 65 6799-5566
- Taiwan: (886) 2-227-83199
- USA: 1-800-283-5853

Visit our website for a complete list of phone numbers.

## ***Unpacking***

The IT100 products come with the accessories listed below. If something is damaged or missing, contact the place of purchase immediately.

### ***ITK100 IntelliTone Pro Kit***

- IT100 Toner with 9 V battery
- IT100 Probe with 9 V battery
- 1 RJ11 to RJ11 patch cord
- 1 RJ45 to RJ45 patch cord
- Test lead set, banana jacks to alligator clips
- F connector adapter, female to female
- Quick Reference Guide
- Product Manuals CD

### ***IT100 IntelliTone Pro Toner***

- IT100 Toner with 9 V battery
- 1 RJ11 to RJ11 patch cord
- 1 RJ45 to RJ45 patch cord
- Test lead set, banana jacks to alligator clips
- F connector adapter, female to female
- Quick Reference Guide
- Product Manuals CD







### ***IT100 IntelliTone Pro Probe***

- IT100 Probe with 9 V battery
- Quick Reference Guide
- Product Manuals CD

## Safety Information

Table 1 describes the international electrical symbols used on the tester and in this manual.

Table 1. International Electrical Symbols

	Warning or Caution: Risk of damage or destruction to equipment or software. See explanations in the manual.		
	Warning: Risk of electric shock.		
	This equipment not for connection to public communications networks, such as active telephone systems.		
	Do not put circuit boards in the garbage. Dispose of circuit boards in accordance with local regulations.		
	Conformité Européenne		Meets C-Tick EMC standard

### Warning

- Never use the toner or probe on circuits of more than 100 V.

- Never use the toner, probe, or test leads if they are damaged. Inspect the cases and test leads for damage before use.
- Disconnect unused test leads and connectors from the toner when testing telephone circuits.
- Never open the case except to change the battery; no user-serviceable parts are inside.
- Turn off the toner or probe and disconnect all test leads before replacing the battery.
- Use only a 9 V battery, properly installed in the case, to power the toner and probe.
- If this equipment is used in a manner not specified by the manufacturer, the protection provided by the equipment may be impaired.

### Caution

- Avoid touching the probe tip to patch panel connections and using the tip to dig into cable bundles. Doing so regularly may damage the probe tip over time.
- To avoid unreliable test results, replace the battery as soon as the low battery indication appears.



## Battery Status

LEDs on the toner and probe light for 1 second at power on to indicate the battery status:



Toner battery status LED



Probe battery status LED

**Green:** Battery is good.

**Yellow:** Battery is marginal.

**Red:** Battery is low.



See "Battery Life and Replacement" on page 11 for more information on the battery.



## Auto Power Down

The toner turns off automatically after approximately 2 ½ hours of inactivity. The probe turns off automatically after 1 hour of inactivity.



To reactivate the toner or probe, turn the rotary switch to any position except **OFF**.

## Locating and Isolating Terminated UTP/STP Cables with the IntelliTone



The IntelliTone Pro toner provides two toning modes for locating and isolating cables; one digital tone  and one analog tone .

With the toner set to digital tone mode, the probe can be set to either locate  or isolate .

Both toning signals are available at all connectors on the toner.

The digital tone  is optimized for 4 pair UTP data environments and the SmartTone analog tone  is optimized for two wire locating.

To locate and isolate cables using the digital tone, do the following:

1. Connect the IT100 toner to a jack or punch-down block as shown in Figure 1.
2. Turn the toner's rotary switch to  .
3. Turn the IT100 probe's rotary switch to  (locate).
4. Use the probe to find the general location of the tone at a cable rack, patch panel, or behind a wall. The **SYNC** LED lights up green when the probe is receiving the IntelliTone signal.

In locating mode, the probe's LEDs light up from 1 to 8 as the signal strength increases. The higher the number, the stronger the signal.

*Note*

*If you cannot locate the IntelliTone signal on 2-conductor cables, the cable may be shorted. Use the continuity test (page 10) to check for shorts.*

5. Turn the probe's rotary switch to  (isolate).
6. Use the probe to isolate the tone source in the cable bundle or at the patch panel. The **SYNC** LED lights up green when the probe is receiving the IntelliTone signal.

In isolating mode, the probes LEDs light up from 1 to 8 as the signal strength increases.

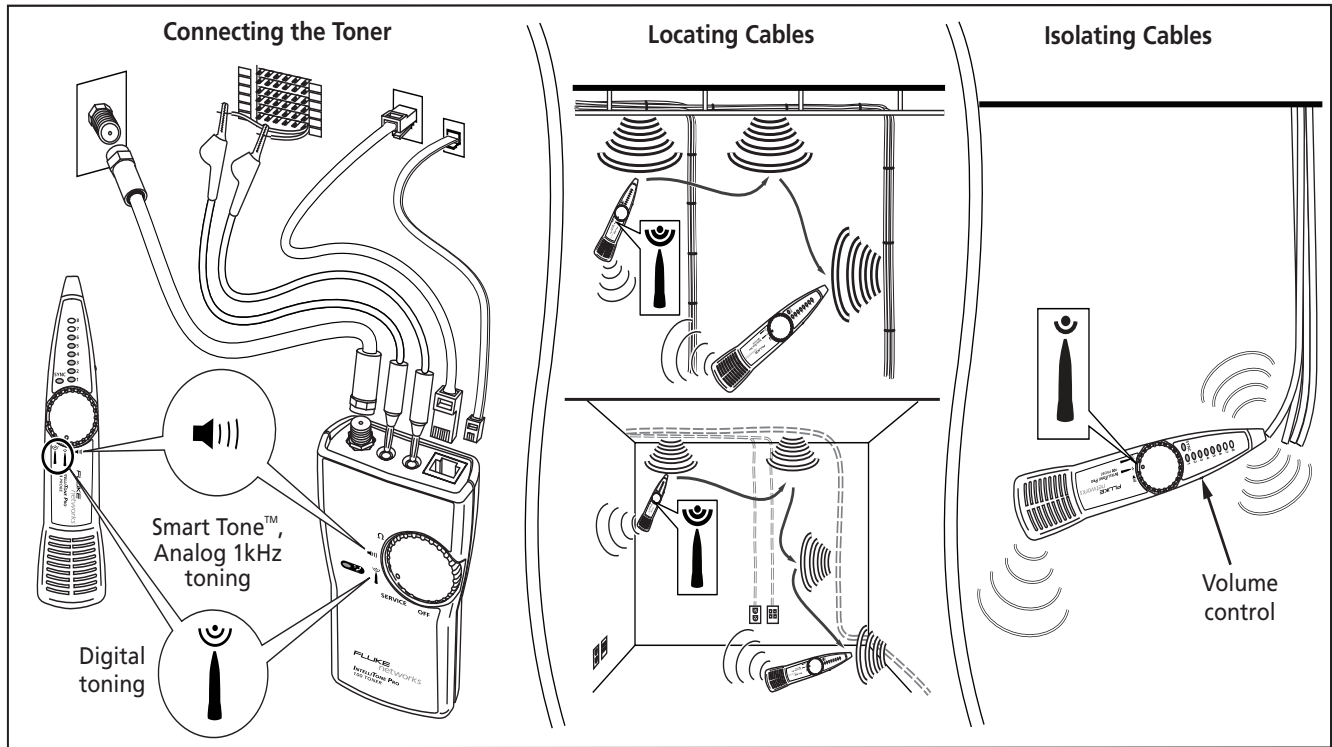



Figure 1. Locating and Isolating Cables

asx04f.eps

## ***Isolating Individual Wire Pairs with the SmartTone Analog Function***

The  position on the IT100 probe and toner lets you use the probe to trace using an analog tone.

SmartTone is intended for use on dry pairs of wires that are un-terminated at both ends of the run. It is not intended to be used on live wires with a DC power source (e.g., live telephone lines), nor will it work on wire pairs that are carrying AC signals. SmartTone works on many types of wire pairs including twisted pair, house wiring, and coax (the shield is one wire and the center conductor is the other wire of the pair).

### ***SmartTone Positive Identification***

1. The toner red lead must be connected to one of the wires of the pair, and the black lead must be connected to the other wire of the pair.
2. Put the toner and probe in the  position.
3. At the far end of the cable run, place the probe near the wires you are tracing. Pick the pair that gives the loudest signal in the toner speaker.
4. Short and release the two wires of the pair. If you hear a change in the pattern of the tone, then you have located the target pair of wires.

If you don't hear a change in the tone pattern, then pick a different pair and try again until you find the pair that causes the tone pattern to change.

## Validating Telephone Service and Polarity

The toner detects telephone service and circuit polarity on its banana, RJ11, and RJ45 jacks.

### Note

*This test requires power from the Central Office battery.*

1. Turn off the toner.
2. Connect the toner to the circuit as shown in Figure 2. Disconnect unused test leads and connectors from the toner.
3. Turn the toner's rotary switch to **SERVICE**.
4. The LEDs indicate telephone service and polarity as shown in Figure 2.

The toner checks for continuity between the red and black test leads and across the middle pair of the RJ45/RJ11 jack (line 1).

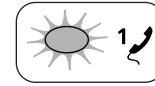

Figure 2. Validating Telephone Service and Polarity

asx01f.eps

## Testing for Continuity

You can use the toner to test circuits and components for continuity.

1. If you are testing a circuit, verify that it is not powered. Use the toner's **continuity  $\Omega$**  function to check for continuity. Use a voltage meter to check other types of circuits for power.
2. Turn off the toner.
3. Connect the toner to the circuit or component as shown in Figure 3.
4. Turn the toner's rotary switch to  $\Omega$ .
5. The <sup>1</sup> LED indicates an open or closed circuit as shown in Figure 3.

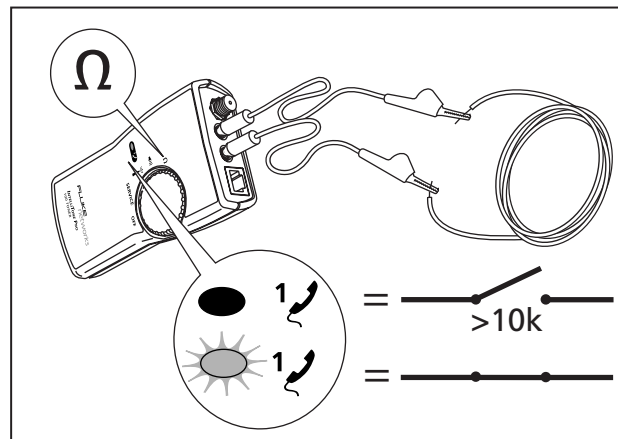

asx09f.eps

Figure 3. Continuity Test

## Validating Cable Maps with an IT200 Probe

You can use the IT100 toner with an IT200 probe to validate the cable map on RJ11 and RJ45 connectors. See the ITK100/ITK200 Quick Reference Guide or the IT200 Users Manual on the Product CD for details.

### **Maintenance**

Clean the case with a soft cloth dampened with water or water and a mild soap.

#### **Caution**

To avoid damaging the case, do not use solvents or abrasive cleansers.

### **Battery Life and Replacement**

The toner and probe batteries last for about 20 hours of typical use.

Figure 4 shows how to replace the battery in the toner and probe.

#### **Warning**

To avoid possible electric shock or personal injury:

- Turn off the toner or probe and disconnect all test leads before replacing the battery.
- Use only a 9 V battery, properly installed in the case, to power the toner and probe.

#### **Caution**

To avoid unreliable test results, replace the battery as soon as the low battery indication appears. See "Battery Status" on page 5.

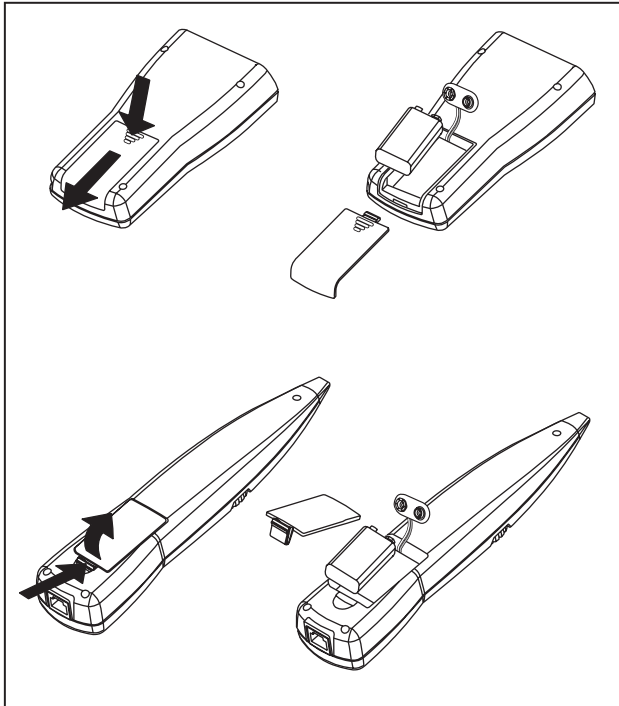

asx10f.eps

Figure 4. Replacing the Battery

### Accessories

To order accessories (Table 2), contact Fluke Networks.

For the latest list of IT100 accessories and other cable testers visit the Fluke Networks website at [www.flukenetworks.com](http://www.flukenetworks.com).

Table 2. Accessories

Accessory	Fluke Networks Model or Part Number
Test lead set, banana jacks to alligator clips	MT-8203-22
Test lead set, banana jacks to alligator clips with bed of nails	MT-8203-20
Soft carrying case	MT-8202-05



## Specifications

Specifications apply at 23 °C (73 °F), unless otherwise noted.

### Environmental and Regulatory Specifications

<b>Operating temperature</b>	32 °F to 104 °F (0 °C to 40 °C)
<b>Storage temperature</b>	-4 °F to +140 °F (-20 °C to +60 °C)
<b>Operating relative humidity (% RH without condensation)</b>	95 % (50 °F to 95 °F; 10 °C to 35 °C) 75 % (95 °F to 104 °F; 35 °C to 40 °C) uncontrolled < 50 °F (< 10 °C)
<b>Vibration</b>	Random, 2 g, 5 Hz-500 Hz
<b>Shock</b>	1 m drop test
<b>Safety</b>	EN 61010-1 1 <sup>st</sup> Edition + Amendments 1, 2
<b>Altitude</b>	3000 m
<b>EMC</b>	EN 61326-1

***IT100 Toner Electrical and Functional Specifications***

<b>Output power</b>	5 V p-p
<b>Voltage protection</b>	100 V
<b>Tone frequencies</b>	1 digital tone 500 kHz 1 analog tone 1 kHz
<b>Battery type and life</b>	9 V alkaline (NEDA 1604A or IEC 6LR61); 20 hours typical
<b>Auto power down</b>	Turns off automatically after 4 hours of inactivity

***IT100 Probe Electrical and Functional Specifications***

<b>Tone detection</b>	Detects IntelliTone™ signal from IT100 or IT200 toner and 1 kHz signal from other toners.
<b>Battery type and life</b>	9 V alkaline (NEDA 1604A or IEC 6LR61); 20 hours typical
<b>Auto power down</b>	Turns off automatically after 1 hour of inactivity

**Feature Compatibility**

IntelliTone Toner/Probe Feature	Product Compatibility	
	IntelliTone Toner and Probe	Works with Legacy Toner or Probe
IntelliTone locate mode	◆	
IntelliTone isolate mode	◆	
Cable map validation	○	
Shield validation	○	
Analog 1 kHz tone	◆	◆
Visual / audible proximity indicators	◆	◆
○ Requires IntelliTone IP200 probe.		

**Certifications and Compliance**

 Conforms to relevant European Union directives.

 Meets C-Tick EMC standard.  
N10140

**Dimensions**

Toner: 5.54 in x 2.94 in x 1.25 in  
(14.1 cm x 7.5 cm x 3.2 cm)

Probe: 8.73 in x 1.88 in x 1.26 in  
(22.2 cm x 4.8 cm x 3.2 cm)

**Weight (with battery)**

Toner: 6.0 oz (170 g)

Probe: 4.7 oz (133 g)

