

PRODUCT CODE: SBS25G
SPACER BAR SADDLE

DESCRIPTION

25mm Spacer Bar Saddle

FINISH

BZP

MATERIAL

Pressed Steel

PACKAGING

Packed in qty 100

ADDITIONAL NOTES

Conforms to BS EN61386-1:2008
Compliant to LU Standard 1-085 (for use on surface & sub-surface locations)

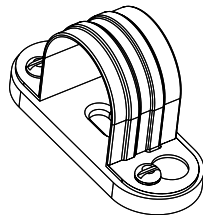
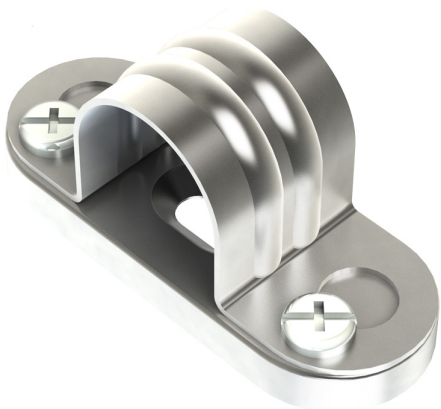

Isometric view

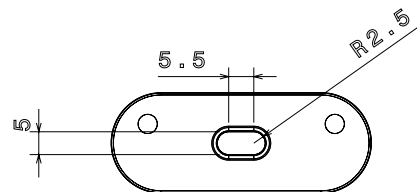

Bottom view

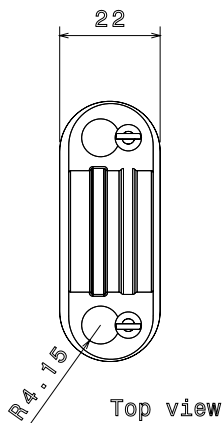

Top view

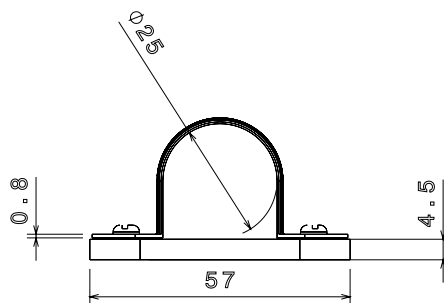

Front view

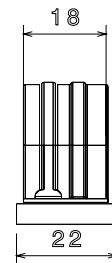

Side view