

## Modular Y-Adapters

Y-Adapters are available as "splitters" which convert one 4-pair jack into two jacks. The Y-Adapters utilize Simon's patented UP-2468 plug which allows adapters to be used in 6- or 8-position jacks. The adapter body can be rotated 180° to view either the colored icons or the Y-Adapter pinouts, which are printed on the opposite side.

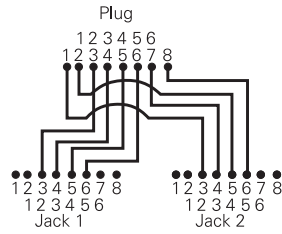

YU4-U2-U2 . . . . .  
Splits a 4-pair USOC jack for Token Ring or voice applications at either jack



YA4-U2-U2 . . . . .  
Splits a 4-pair T568B jack for Token Ring or voice applications at either jack

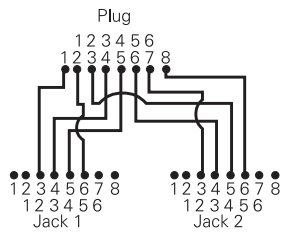

YT4-E2-E2 . . . . .  
Splits a 4-pair T568A/B jack for 10BASE-T applications at either jack

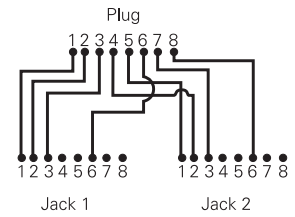

YT4-U2-U2 . . . . .  
Splits a 4-pair T568A jack for Token Ring or voice applications at either jack

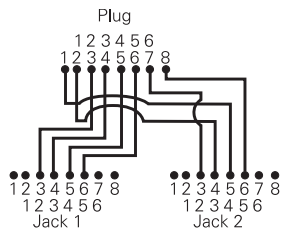

YA4-A3-U1 . . . . .  
Splits a 4-pair T568B jack for 1-, 2- or 3-pair voice and 1-pair voice/modem

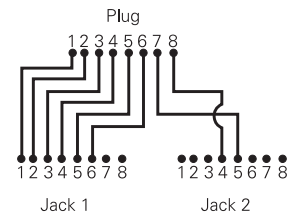

YT4-E2-U2 . . . . .  
Splits a 4-pair T568A/B jack for 10BASE-T and Token Ring or voice applications

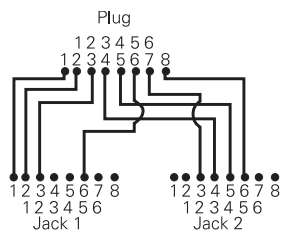

Y-BRIDGE . . . . .  
Bridges all jack pairs. Compatible with any jack wiring. Provides an additional 4-pair jack with the same wiring.

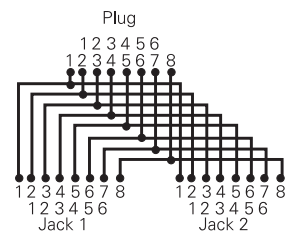

## Modular 4-Way Splitter

Simon's modular 4-way splitter provides access to each individual pair of a 4-pair modular outlet. The splitter converts a single 4 pair outlet to 4 individual 1-pair, 6-position outlets to enable four unique modular connections. The universal plug design enables compatibility with both 6- and 8-position outlets.

YA4-4U1 . . . . . Modular 4-way splitter, T568B  
YT4-4U1 . . . . . Modular 4-way splitter, T568A

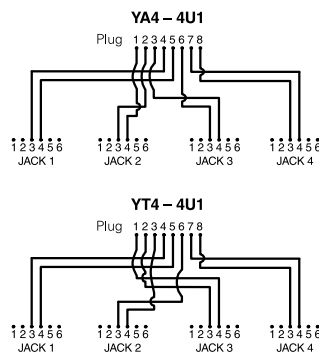

Note: These modular adapters meet category 3 transmission specifications.